

Data Sheet



Article number: 2314451405

Description: E+G Cast iron wheel 451405
RE.F4-250-RBL - loose wheel

Measures

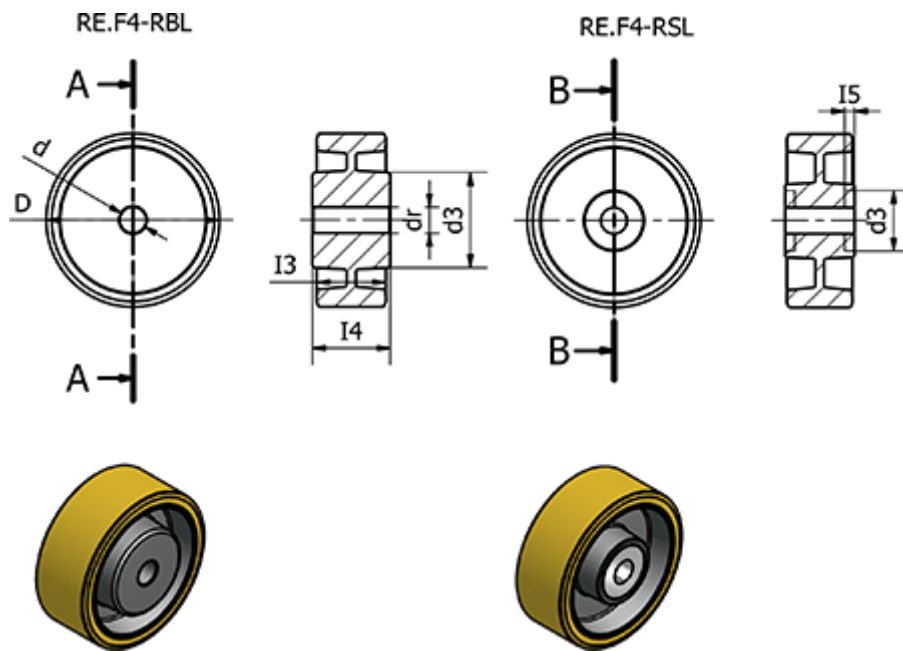

Code	= 451405	Max static load (N)	= 28000
d	= 250	Rolling resistance (N)	= -
d3	= 95	Type	= RE.F4-250-RBL
dr	= 60	Weight (g)	= 11000
Dynamic carrying capacity (N)	= 16000		
I3	= 80		
I4	= 80		
I5	= -		